

LINEAR HIGH BAY LIGHTS



PRODUCT FEATURES:

1000LED Linear High / Low Bay Lighting series. With its slim design, the LHB is the perfect LED replacement for T5 and T8 fluorescent high bays. The LHB delivers efficient, uniform, high lumen output for high and low bay applications in industrial, retail and commercial interiors. This energy-efficient fixture features high-performance optics which deliver clear or whiter, brighter light while using significantly less energy when compared to traditional high bay lighting.

MODEL #	
PROJECT:	
NOTES:	
DATE:	
PREPARED BY:	

Additional Information:

- Power: 150W
- Input: AC 120-277V
- CCT : 5000K
- Output: 19800 LM
- Light Source: LUMILEDS
- Driver: SOSEN POWER

Structure Features:

- Shell Material: Aluminum/PC
- Color: White
- Weight: 12.7 lbs.



PRODUCT APPLICATIONS:

The 1000LED Linear High Bay LED Lighting Series can be widely used in Warehouses, Industrial Areas, Gymnasiums, Stadiums, Exhibition Halls, Workshops, Manufacturing Facilities, Distribution Centers, Storage Areas, Grocery Stores, High Bay Garages and Big Box Retailers

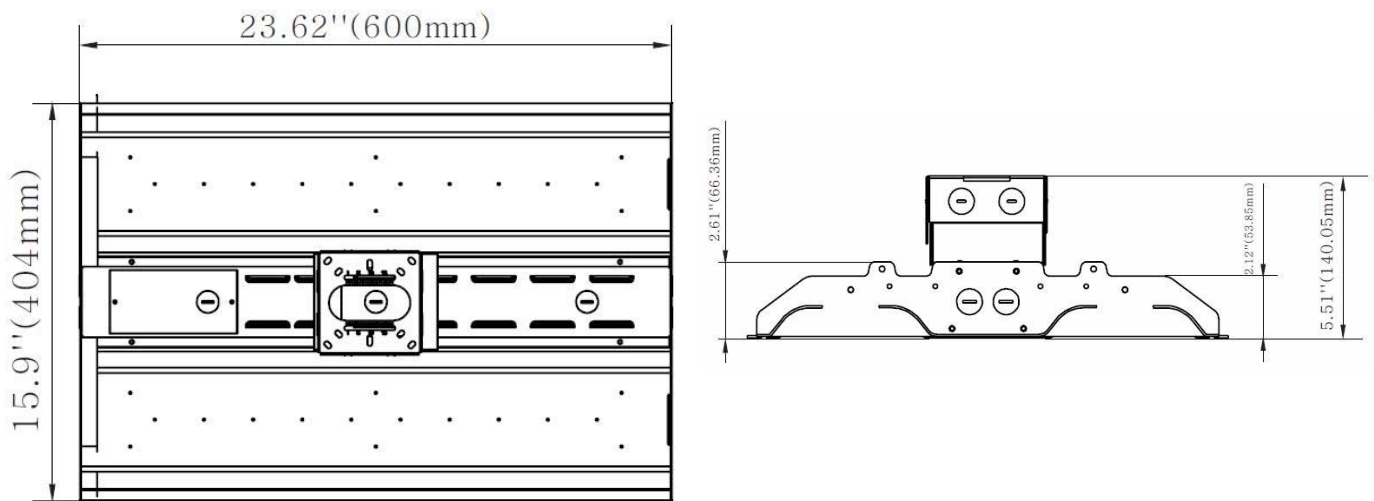

LINEAR HIGH BAY LIGHTS

TECHNICAL PARAMETERS:

Type	1L-2FLHB10W27-XXK-Y - Z		
Power	150W	Frequency Range	50/60Hz
Luminous Flux	19800 LM	CRI	Ra>80
Lum Efficiency	>128LM/W	Beam Angle	>115°
LED Chip Brand	Philips	Working Temperature	-30 - +45°C
Power Factor	>98%	Storage Temperature	-40 -+80°C
LED Driver	SOSEN	Color Temperature	4000K/5000K/5700K ±500K
Net Weight	12.7 LBS	Warranty	5 YEARS

IRRADIATION AREA: Photometry & Illuminance

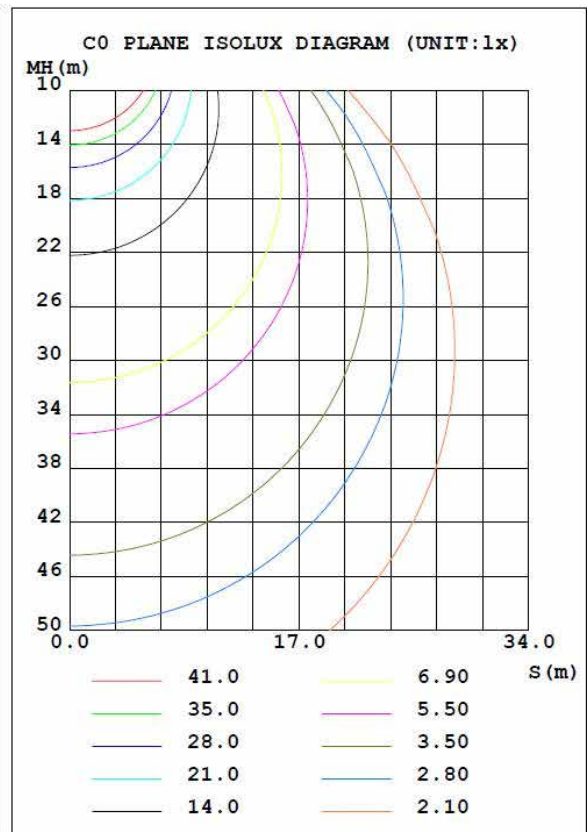
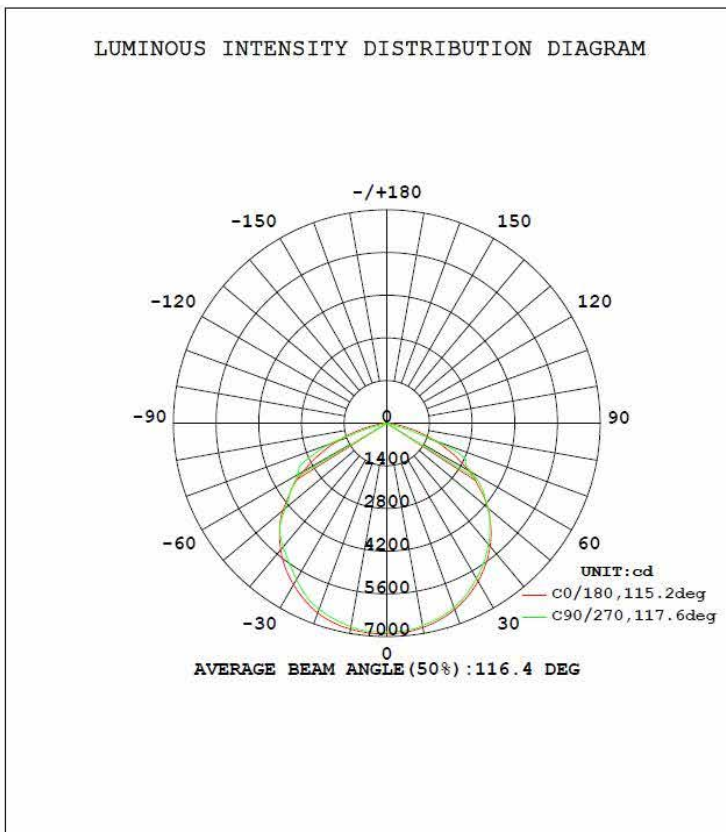

LINEAR HIGH BAY LIGHTS

ORDERING INFORMATION:

EXAMPLE: 1L-2FLHB 15W 27-50K-C-M

1L	CP	15W	27	50K	C	M
Company	Product	Power	Voltage	ColorTemp	Cover	Control
1000LED	2FLHB Linear High Bay	10W (100W) 15W (150W)	27 AC120-277V	30K (3000K) 40K (4000K) 50K (5000K) 57K (5700K) ± 500K	C Clear Cover F Frosted Cover	10V Dimming 1-10V M Motion Sensor

PRODUCT CERTIFICATIONS:

