

1000LED[®]

LED FLOOD LIGHTING

**45W
70W**



- ◆ Lumileds LED, high luminous efficiency and long working life.
- ◆ High efficiency LED Driver, the wide range input voltage AC120-277V.
- ◆ Die Cast aluminium cooling design, high quality and better cooling for LED $T_j < 85^{\circ}\text{C}$.
- ◆ Excellent Optics design, greatly improve the light utilization and evenness.
- ◆ 1-10V Dimming.
- ◆ Photocell Control Available .

Product Description

1000LED Flood Lighting series can be widely used in indoor or outdoor lighting (Wet location), Excellent for Museums, Art Galleries, Shopping Malls, Office Buildings, Landscapes and many more applications.

45W 70W LED Flood Light



Specifications

Unit : inch(mm)

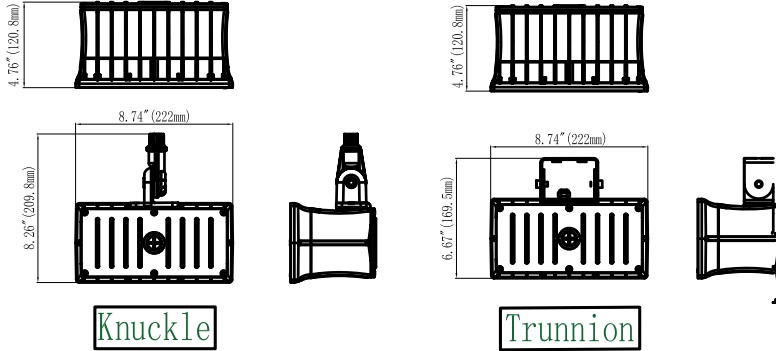

Structure Features

- Shell materials: Aluminum & PC.
- Finish: Dark Bronze(Standard)
- Net weight : 45W:1.89Kg (4.2 lbs)
70W:2.09Kg (4.6 lbs)
- Product Size:222mmX209.8mmX120.8mm
8.74''X8.26''X4.76''
- Carton Size:235mmX175mmX150mm
9.25''X6.89''X5.9''(4 Pcs/CTN)

Technical Parameters

1L-FL45W27-XXK-Z-U-Y-G2/1L-FL07W27-XXK-Z-U-Y-G2

Power	45W/70W	Beam Angle	98°
Input Voltage	AC120-277V	LED Brightness Decay	< 5%/6000 hrs
PF	>0.95	Working Life	> 50000 hrs
Driver Efficiency	>88%	Working Temperature	-30 - +45°C
Luminous Flux	45W:6750 Lm/70W:10441 Lm	Storage Temperature	-40 -+80°C
Color Temperature	4000K/5000K	Protection Level	Wet Location
CRI	Ra>70	Cable	Input Connect,0.5m
Optional dimming function	1-10Vdc	SystemEfficacy(Lm/w)	150 Lm/w(45W/70W)

Photometry

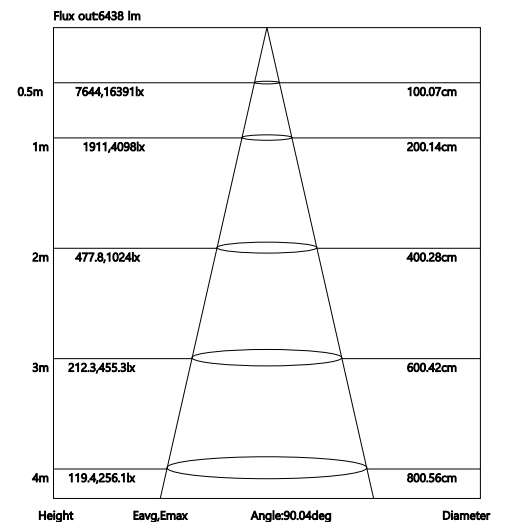
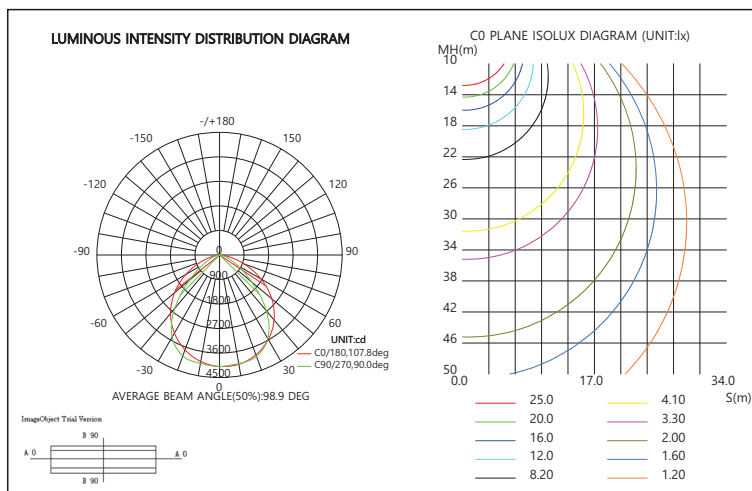

Example: 1L-FL45W27-XXK-Z[D,W,B,S]-U[K,T]-Y[Black,P]-G2

1L	FL	45W	27	XXK	Z	U	Y	G2
Company	Product	Power	Voltage	Color Temp	Finish	Mount	Control	
	FL	45W(45W)	27	40K(4000K)	D(Dark Bronze)	K(Knuckle)	P	The second
1000LED	LED	07W(70W)	AC100-277V	50K(5000K)	W(White)	T(Trunnion)	Photocell	generation
	Flood Light			±500K	B(Black)			
					S(Silvery)			

LED FLOOD LIGHT

Installation Guide

⚠ WARNING

PLEASE READ ALL INSTRUCTIONS BEFORE ATTEMPTING INSTALLATION

- To prevent personal injury or product damage only licensed electricians should install.
- To avoid electric shock or component damage disconnect power before attempting installation or servicing.
- This product must be installed in accordance with the national electric code (NEC) and all applicable federal, state and local electric codes and safety standards.
- Disconnect product and allow cooling prior to servicing.
- Any alteration or modification of this product is expressly forbidden as it may cause serious personal injury, death, property damage and/or product malfunction.
- To prevent product malfunction and/or electrical shock this product must be properly grounded.
- This luminaire is designed to operate in ambient temperatures ranging from -30°C to 40°C and to be horizontally mounted with the LEDs facing down.

1. Unpacking

Thoroughly inspect the fixture for freight damage. Freight damage should be reported to the delivery carrier.

2. Install

A

- 1) Connect AC power wire, then twist the light into fixed 1/2 pipe.

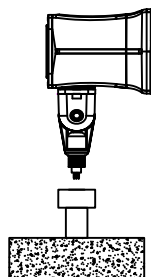

After the angle of the light set, fasten the screw in the middle of adjustable arm. Make sure all connection is fine, the installation is done

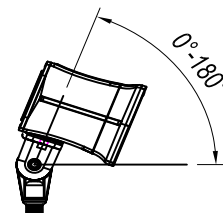
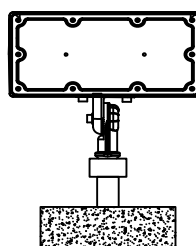

B Trunnion Mounted

- 1) Drill 8mm hole on the wall or ground, please make sure the position of the crew hole match with the following dawning

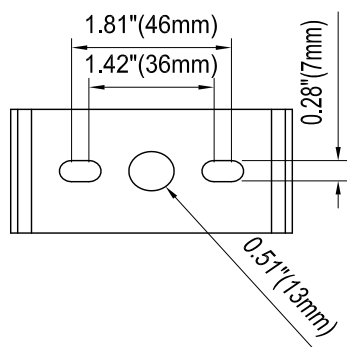

- 1) fixed the bracket on the crew hole, and adjust the angle of light according to your application, fasten the crew in the middle of adjustable arm, then Connect AC power wire. make sure all connection is fine,

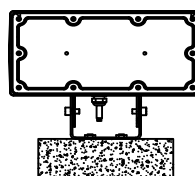

3. Checking

- 1). Does all the wires connect in a correct way as the pictures show below?
- 2). Is the ground lead installed appropriately?
- 3). make sure the photocell function well.