

INSTALLATION GUIDE

PRODUCT APPLICATIONS:

The 1000LED Gas Station Lighting Series can be widely used in indoor or outdoor lighting.

NOTE:

- **New:** refers to mounting a new replacement canopy skin.
- **Replacement:** refers to the complete removal and replacement of an existing fixture.
- **Definition:** Luminaire is a complete lighting unit; i.e. not a replaceable lamp or bulb.

IMPORTANT!

A licensed electrician must disconnect the primary power from the circuit connected to the fixture and provide any lockout tags on the breakers or switches as required by the local electrical codes.

STRUCTURE FEATURES:

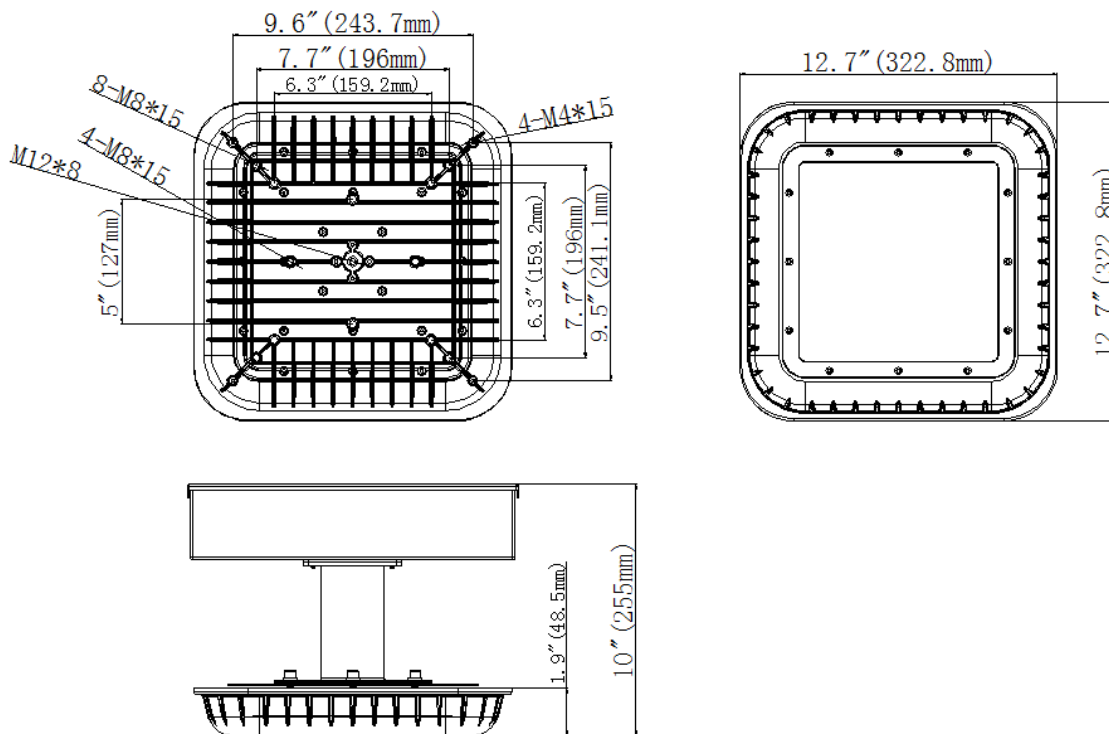

INSTALLATION GUIDE

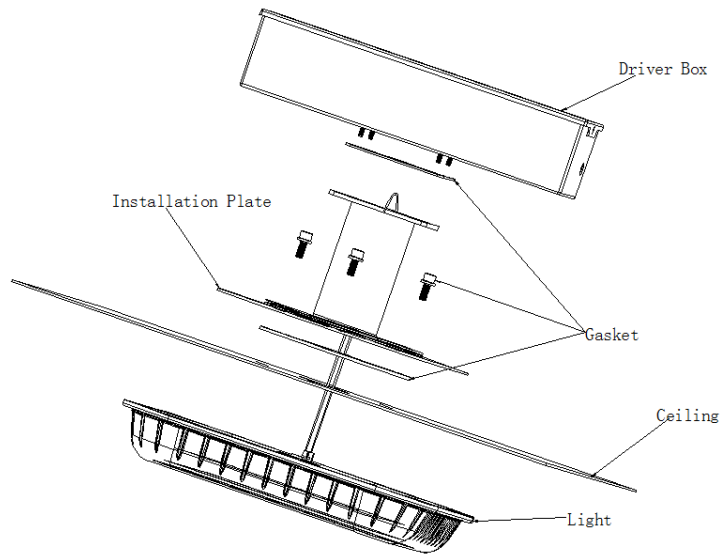

Embedded Installation Instructions:

New: Drill holes in canopy at desired center of light with 2in (50 mm) diameter metal hole saw. 127mm*127mm hole 4(12mm)

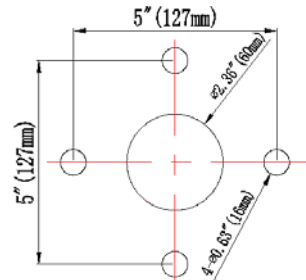
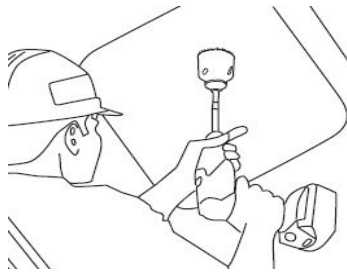

Replacement:

Disconnect wiring from the old fixture and remove fixture from canopy.

Clean installation area:

Clean surface with a cloth and cleaning agent. Continue with Step 1 of New Installation.

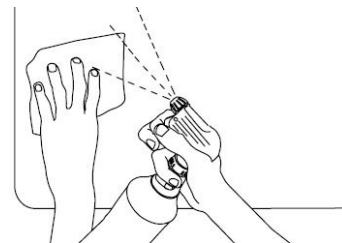
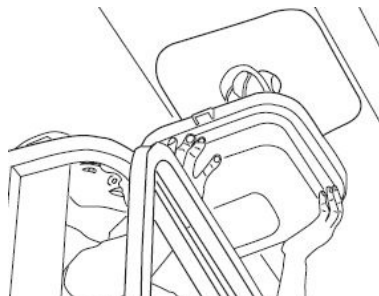

INSTALLATION GUIDE

Step 1: Turn 4pcs M8 screws to the fixture and make the fixture hanged on the ceiling.

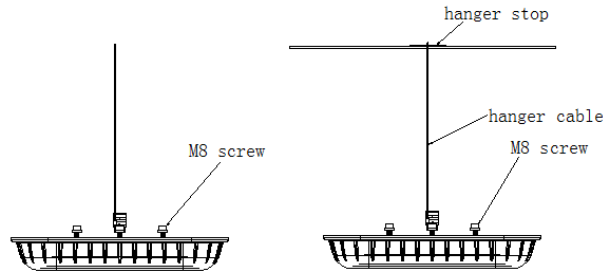

Step 2: Make the holes on the water-proof gasket go through the nuts of the M8 screws and put the gasket on the ceiling, then make the nuts of the M8 screws go through the keyholes on the mounting bracket, and turn the screws tightly to fix the fixture to the mounting bracket.

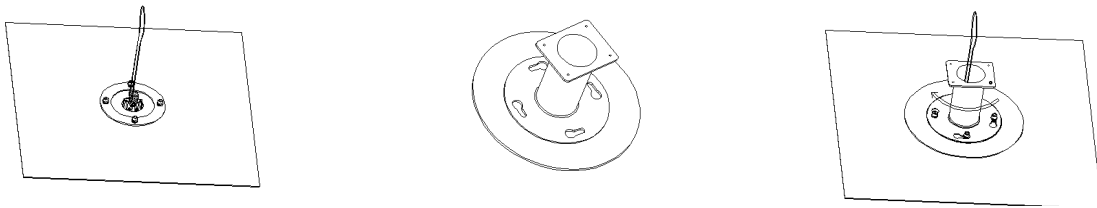

Step 3: Add water-proof gasket both on the bottom of driver box and top of bracket. Fix with 4pcs M4 screws.

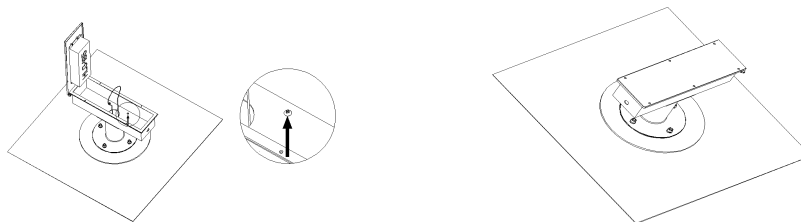

Step 4: Connect the DC wire of fixture to the DC wire of power supply, and then connect the AC input wire.

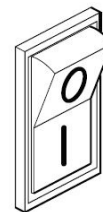
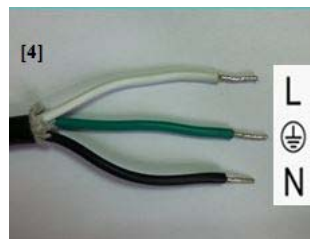

INSTALLATION GUIDE

Surface Mount Installation Instructions:

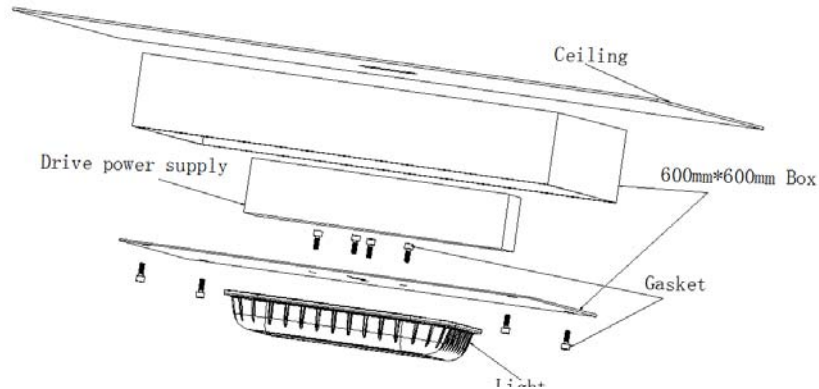

Step 1: Use 4pcs M8 screws to fix the fixture to the cover board of the Shoebox.



Step 2: Fix the cover board to the box on the ceiling, and screw tightly.

Step 3: Connect the power wire correctly, then power on.

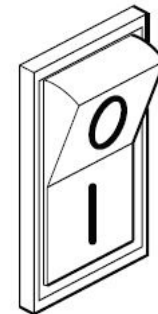
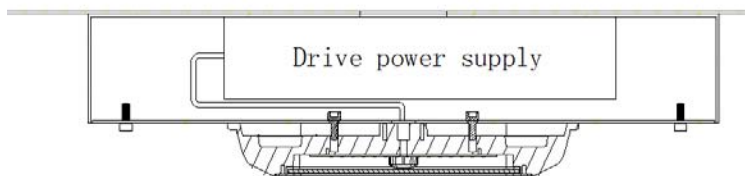

INSTALLATION GUIDE

Retrofit Installation Instructions:

Step 1: Take off the glass cover, Light reflectors, ballast and silicone from the traditional fixture.

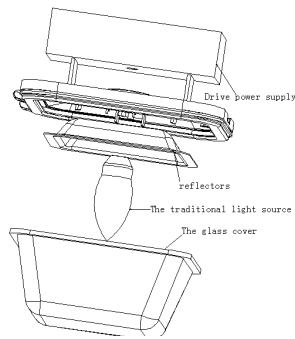

Step 2: Install the silicone from the traditional fixture to the new fixture.

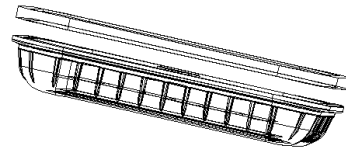

Step 3: Put the new fixture to the fixed mount of the traditional fixture, and then fix with mound layer.

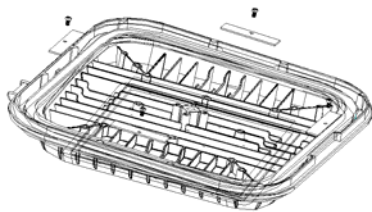

Step 4: Fix the LED driver to the driver box, and connect AC and DC wire, then fasten the fixed mount.

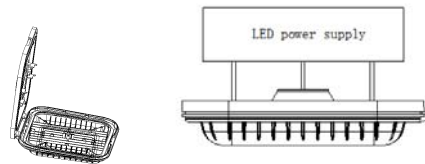

Step 5: Make sure to connect the AC and DC wire correctly, then power on.

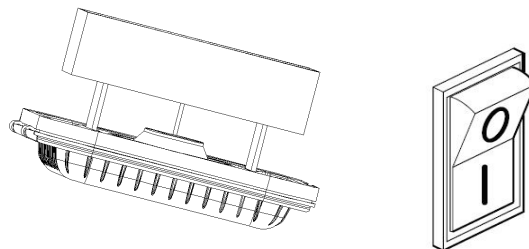

INSTALLATION GUIDE

❖ Quality Assurance

- Quality assurance is based on proper storage, transportation, installation, using and maintenance
- Damages caused by man-made mistake or improper use are not covered by the warranty
- During the warranty period, the manufacturer will provide appropriate support and repair service according to the actual situation

❖ Safety Tips: non-professional personnel is not allowed to do the related operations

- Be careful about the hit or weight of products
- Handle gently in the process of installation and transportation
- Do not energize before completion
- Do not touch the lamp when lighting on
- General heat is normal situation when the fixture is lighting on

❖ Warning

- The product must be installed according to the instructions. Installed by a person familiar with the product, production and product hazards
- Avoid fire and electric shock. When install the lighting fixtures, you need to understand the electrical characteristics. If you are not sure, do not attempt to install. Please contact the electrician
- Understand the structural features and dimensions of lighting before installation
- Do not drill holes or change internal lines when install